

UHF Narrow band radio data module

CDP-RX-02E 434 MHz

CDP-RX-02EP 434 MHz



Operation Guide

Version 1.0 (Oct. 2019)

- This product requires electrical and radio knowledge for setup and operation.
- To ensure proper and safe operation, please read this operation guide thoroughly prior to use.
- Please keep this operation guide for future reference.

CIRCUIT DESIGN, INC.

7557-1 Hotaka, Azumino
Nagano 399-8303 JAPAN
Tel: + +81-(0)263-82-1024
Fax: + +81-(0)263-82-1016

e-mail: info@circuitdesign.jp
<https://www.circuitdesign.jp>

CONTENTS

General description & Features	3
Specifications	4
Pin description	5
Channel and frequency settings	6
Tips for effective use of the reception performance	7
Block diagram	8
Dimensions	9
Test data.....	10
Regulatory compliance information.....	11
Important notice	12
Cautions.....	12
Warnings	12

General description & Features

General description

The CDP-RX-02E and the CDP-RX-02EP are narrowband FM radio receiver modules suitable for various industrial application fields such as wireless data communication, remote control, telemetry or wireless security systems. They are easy to use and integrate into application systems.

The module is equipped with a frequency synthesizer system with micro controller. The available frequency range is from 433.875 MHz to 434.650 MHz (32 channels: 16 ch x 2 groups).

The CDP-RX-02E/CDP-RX-02EP receiver has excellent blocking characteristics and adjacent channel selectivity to meet the requirement of EN 300 220 Receiver category 1.

Features

- Pre-programmed 32 ch in 434 MHz band
- Wide operating temperature range (-20 to +60 degree C)
- Narrow band FM 25 kHz step
- Receiver sensitivity -120 dBm - operating distance 600 m (when combined with CDP-TX-02E)
- High receiver performance of EN 300 220 category 1
- RED and RoHS compliant

Applications

- Radio remote control cranes and machines
- Factory automation M2M
- Security systems
- Alarms
- Telemetry systems

Models

Model name	Channel setting
CDP-RX-02E 434MHz	Dip switches
CDP-RX-02EP 434MHz	Pin connectors

For the CDP-RX-02E, frequency setting is performed with the 4-bit switch. Instead of the 4-bit switch, the CDP-RX-02EP has an 8-pin connector for frequency setting, making it possible to set the channels externally.

There are no other technical and mechanical differences between CDP-RX-02E and CDP-RX-02EP.

Specifications

All ratings at 25°C +/- 5°C unless otherwise noted

Parameter	Rating	Conditions
General characteristics		
Applicable standard	EN 300 220	Receiver category 1
Communication method	One way	
Operating frequency range	433.875 – 434.650 MHz	
Operating temperature range	-20 to + 60 °C	No dew condensation
Storage temperature range	-30 to + 70 °C	No dew condensation
Aging rate	Max. +/- 1 ppm / year	RX Local Freq.
Initial freq. tolerance	Max. +/- 2 ppm	At delivery * ¹
Dimension	30 x 50 x 9 mm	Excluding protrusion
Weight	20 g	Not including the antenna
Electrical specification		
Oscillation system	PLL controlled VCO	
Channel steps	25 kHz	
Number of RF channels	32 channels (16 x 2 groups)	Default channel at delivery B16 (434.650 MHz)
Data rate	300 to 4800 bps	(Pulse length Min. 208 us Max. 20 ms)
Data output level	L = Gnd H = Vcc	
Data polarity	Positive	TX DI vs RX DO
PLL reference frequency	21.25 kHz	TCXO
Antenna impedance	50 ohm	Nominal
Operating voltage	3 – 12 V	
Consumption current	Typ. 30 mA at 3 V	
	Typ. 33 mA at 12 V	
Receiver electrical specification		
Receiver type	Double superheterodyne PLL synthesizer	
Bit error rate (0 error /2556 bits)	Typ. -116 dBm	At DO 4800 bps PN9 (-20°C to + 60°C)
Bit error rate (1% bit error)	Typ. -120 dBm	At DO 4800 bps PN9 (-20°C to + 60°C)
Sensitivity (12 dB / SINAD)	Typ. -120 dBm	At AF fm1kHz, Dev.+/-2.0kHz, CCITT filter (-20 to + 60°C)
Frequency stability	Max. +/- 4 ppm	- 20 to 60°C with reference frequency at 25°C
Blocking * ²	-20 dBm	
Spurious response rejection * ²	-44 dBm	1st Mix, 2nd Mix
Adjacent channel selectivity * ²	-50 dBm	+/- 25 kHz
Adjacent channel saturation * ²	-20 dBm	+/- 25 kHz
Spurious radiation * ²	- 60 dBm	Below 1 GHz
	- 50 dBm	Above 1 GHz
Distortion	- 26 dB	1 kHz Dev = +/-2.0 kHz CCITT filter (RF level -30 dBm)
S/N ratio	35 dB	1 kHz Dev = +/-2.0 kHz CCITT filter (RF level -30 dBm)
RSSI	230 mV +/- 50 mV	At -113 dBm
AF output level	145 mV +/- 30 mV	fmod = +/-2.0 kHz fm = 1.2 kHz (RF level -30 dBm)
	130 mV +/- 30 mV	fmod = +/-2.0 kHz fm = 2.4 kHz (RF level -30 dBm)
RSSI rising time	Typ. 20 ms / Max. 50 ms	Channel change (50 kHz) (-20°C to + 60°C)
	Typ. 40 ms / Max. 70 ms	At power on (-20°C to + 60°C)
Time to valid Data out * ³	Typ. 50 ms / Max. 100 ms	Channel change (50 kHz) (-20°C to + 60°C)
	Typ. 70 ms / Max. 140 ms	At power on (-20°C to + 60°C)

Specifications are subject to change without prior notice

*¹ Initial frequency tolerance is defined as frequency drift within 1 year after the final adjustment

*² The measurement procedures are according to the ETSI EN 300 220.

*³ The valid output signal is determined at the point where the Bit Error Rate meter starts detecting a 4800 bps, 1010 repeated signal. The valid output signal varies with the temperature conditions. You must conduct field testing to verify the waiting time for a valid output signal in the user system.

Pin description

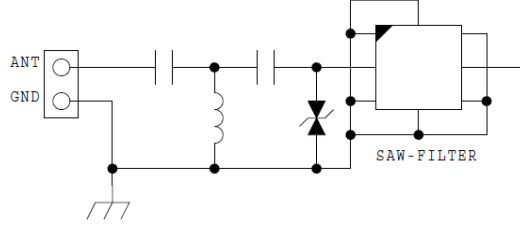
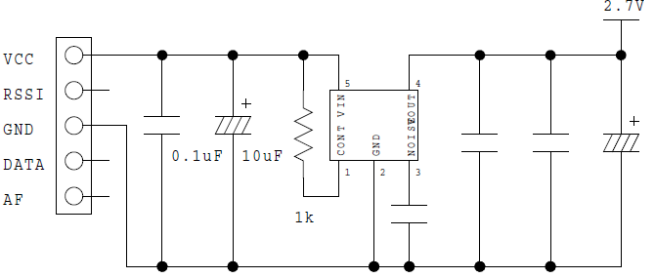
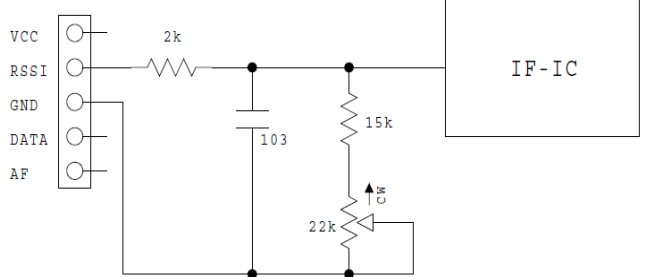
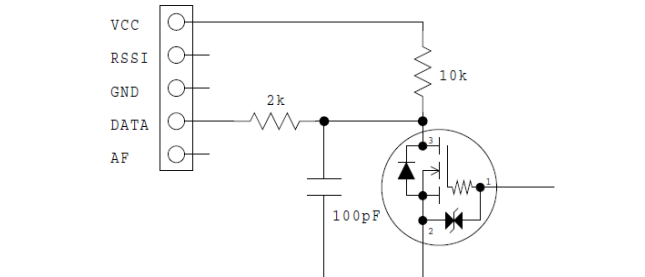
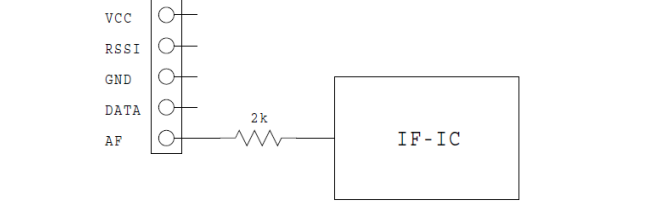
Pin name	I/O	Description	Equivalent circuit
ANT	I	RF input terminal Connect an antenna of 50 Ω impedance. Note that the antenna performance significantly changes depending on the connection condition, shape, and surrounding environment, and may affect the reception sensitivity and operation distance.	
GND	I	The ground for the power supply. Connect it to the ground plane as well as to the bottom part of the case. The ground plane has an impact on the range and the stability of operation.	
VCC	I	The power supply terminal. The supply voltage is DC 3.0 to 12 V. Power supply noise and ripple have an impact on performance, so eliminate them as far as possible with filters and capacitors.	
RSSI	O	The receive level output of the receiver. The strength of the RF level (electric field intensity) is output as a direct-current voltage.	
DATA	O	Digital data output terminal Interface voltage: H = Vcc L = GND	
AF	O	The demodulated output of the receiver. The DC offset is about 1 V. Refer to the specifications for the amplitude level.	

Channel and frequency settings

By use of a chip mounted 4-bit switch or pins and a jumper on the PCB, you can select easily between the 32 channels. The 32 channels are divided into 2 groups: Group A and Group B. Each group of channels can be selected by soldering the jumper ON or OFF. When the jumper (JP2) is ON, Group A is selected. When the jumper is OFF, Group B is selected. There are 16 channels in each group and they can easily be selected using the 4-bit switch or pins. Before shipment all the modules are set to Group B and all the 4 bits of the switch or pins are set to OFF (434.650 MHz).

Channel Table

Ch	Freq. (MHz)	4-bit Switch or PIN status *				Jumper	Ch	Freq. (MHz)	4-bit Switch or PIN status *				Jumper
		1	2	3	4				1	2	3	4	
A1	433.875	ON	ON	ON	ON	ON	B1	433.900	ON	ON	ON	ON	OFF
A2	433.925	OFF	ON	ON	ON	ON	B2	433.950	OFF	ON	ON	ON	OFF
A3	433.975	ON	OFF	ON	ON	ON	B3	434.000	ON	OFF	ON	ON	OFF
A4	434.025	OFF	OFF	ON	ON	ON	B4	434.050	OFF	OFF	ON	ON	OFF
A5	434.075	ON	ON	OFF	ON	ON	B5	434.100	ON	ON	OFF	ON	OFF
A6	434.125	OFF	ON	OFF	ON	ON	B6	434.150	OFF	ON	OFF	ON	OFF
A7	434.175	ON	OFF	OFF	ON	ON	B7	434.200	ON	OFF	OFF	ON	OFF
A8	434.225	OFF	OFF	OFF	ON	ON	B8	434.250	OFF	OFF	OFF	ON	OFF
A9	434.275	ON	ON	ON	OFF	ON	B9	434.300	ON	ON	ON	OFF	OFF
A10	434.325	OFF	ON	ON	OFF	ON	B10	434.350	OFF	ON	ON	OFF	OFF
A11	434.375	ON	OFF	ON	OFF	ON	B11	434.400	ON	OFF	ON	OFF	OFF
A12	434.425	OFF	OFF	ON	OFF	ON	B12	434.450	OFF	OFF	ON	OFF	OFF
A13	434.475	ON	ON	OFF	OFF	ON	B13	434.500	ON	ON	OFF	OFF	OFF
A14	434.525	OFF	ON	OFF	OFF	ON	B14	434.550	OFF	ON	OFF	OFF	OFF
A15	434.575	ON	OFF	OFF	OFF	ON	B15	434.600	ON	OFF	OFF	OFF	OFF
A16	434.625	OFF	OFF	OFF	OFF	ON	B16	434.650	OFF	OFF	OFF	OFF	OFF

* B16: Default setting

4 bit switch: ON = L (GND) OFF = H (Open)

PIN status: ON = L (Short to GND pin) OFF = H (Open)

JP2: Frequency Group Setting (Switch: ON = "L" / OFF = "H")

Group A: Jumper ON Group B: Jumper OFF (Default)

(Example) Set to channel A5 (434.075 MHz)

Group A: JP2: Jumper ON Dip Switch / PIN: ON, ON, OFF, ON (ON: Short to GND)

Position of the JP1, JP2, DIP SW and Pins.

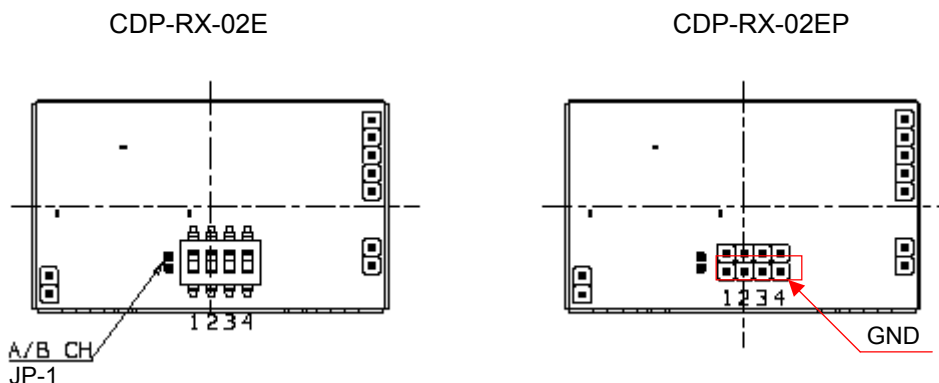

Tips for effective use of the receiver performance

The CDP-RX-02E/CDP-RX-02EP is designed for high sensitivity to obtain radio signals over long distances. On the other hand, it may be sensitive to noise from the microcomputer and surrounding digital circuits due to its high sensitivity.

For stable operation, it is recommended to solder the shield case to as wide a ground pattern as possible.



 Soldering point

The module is also designed to be vibration resistant. However there is a limit to the amount of shock and vibration it can sustain due to its construction.

When using the module in the application where vibration is always present, use a shock absorber or fix the PCB at the vicinity of the four corners of the receiver module in addition to fixing the four corners of the PCB on which the radio module is mounted.

Block diagram

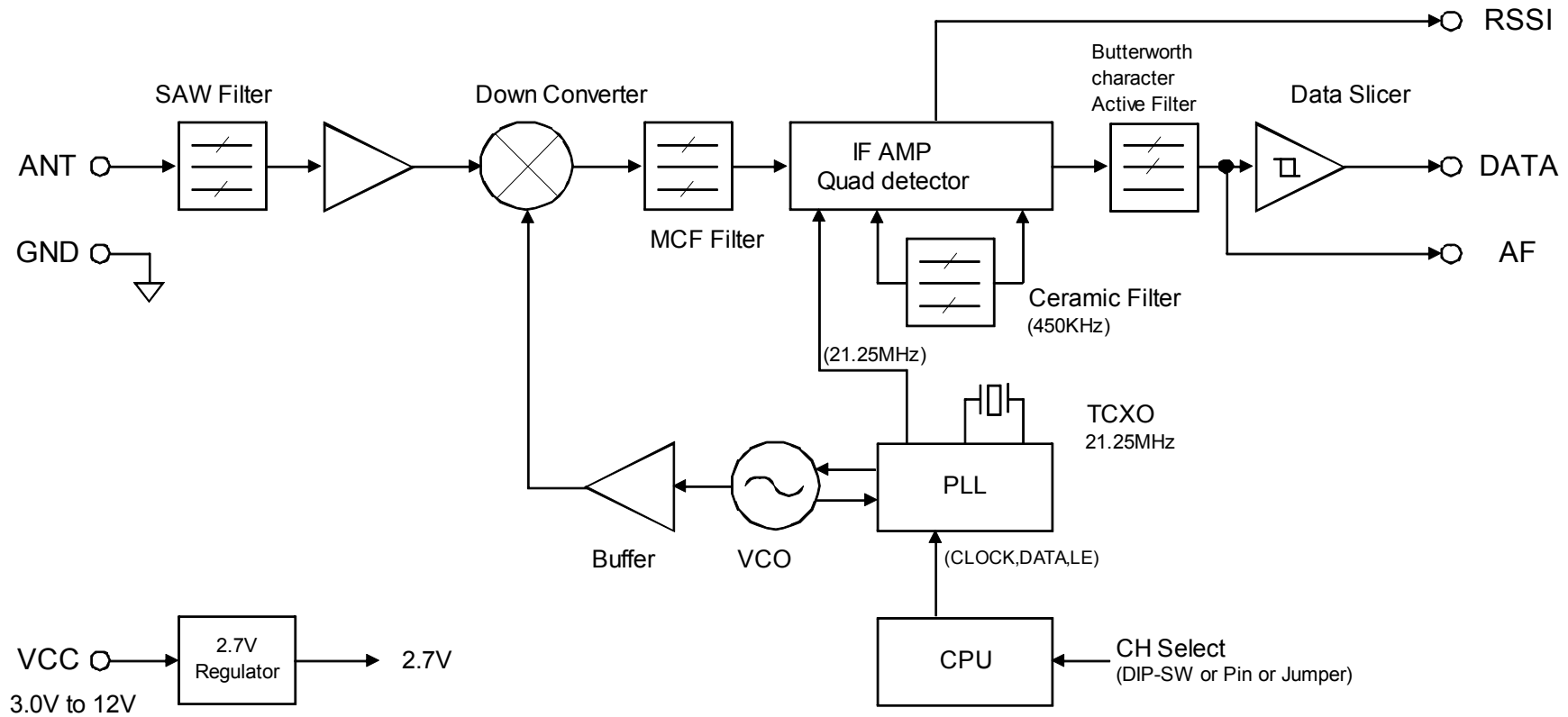

Dimensions

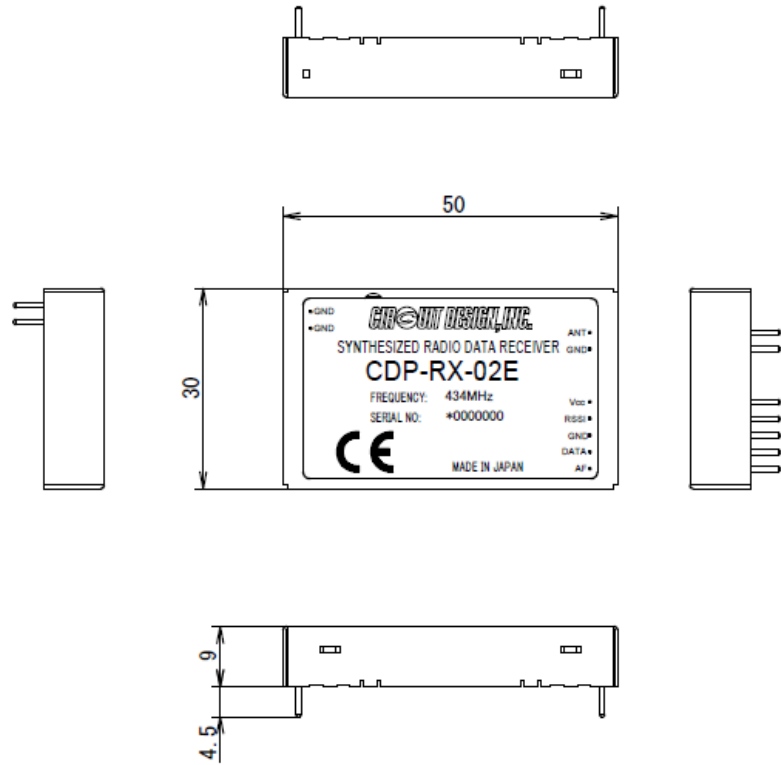

Reference hole position for PCB mounting (Top view)

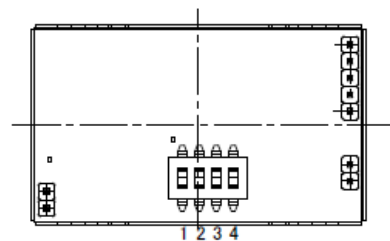
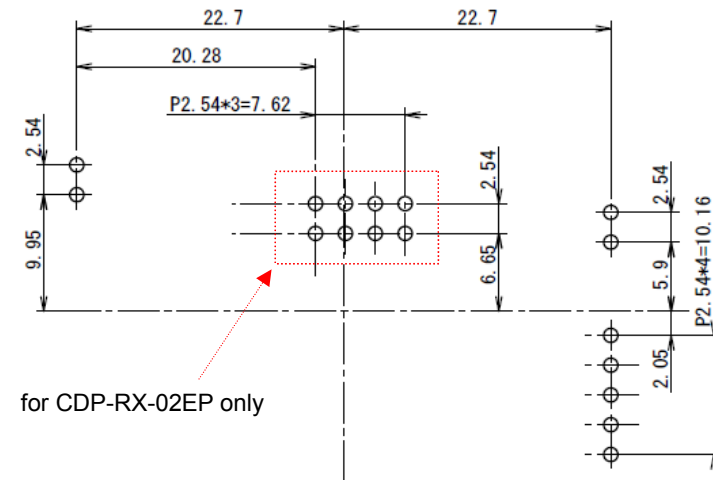

CDP-RX-02EP

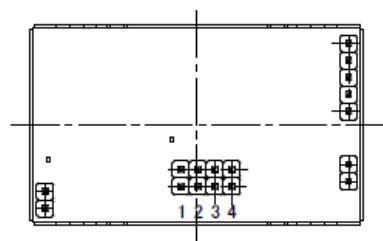

CDP-RX-02EP

Test data

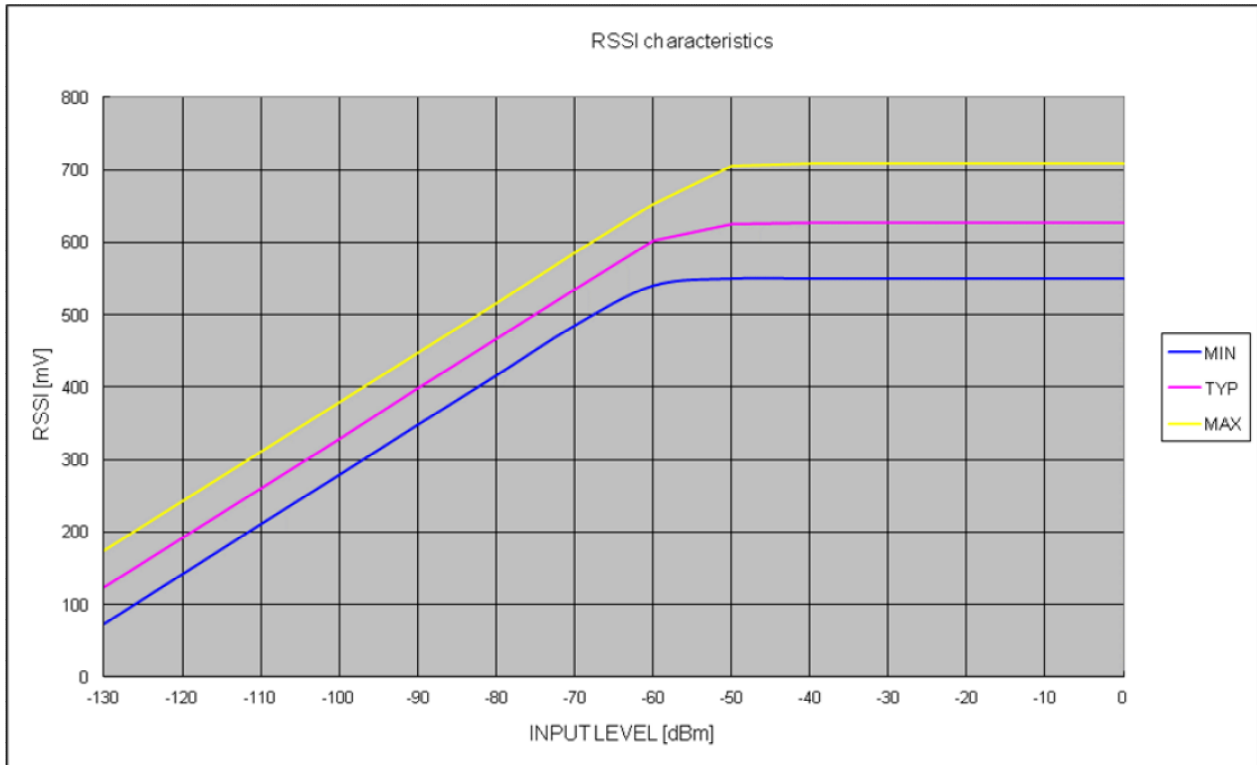

Regulatory compliance information

Declaration of Conformity

Hereby, Circuit Design, Inc. declares that the CDP-RX-02E and the CDP-RX-02EP are in compliance with RE Directive (2014/53/EU).

The full text of the EU Declaration of Conformity is available at www.circuitdesign.jp.

Cautions related to regulatory compliance when embedding the CDP-RX-02E/CDP-RX-02EP

This product requires electrical and radio knowledge for setup and operation.

Supply voltage

To fulfill the safety requirements, the CDP-RX-02E/CDP-RX-02EP should be connected to a proper power supply within the specified voltage range.

Enclosure

To fulfill the requirements of EMC and safety requirements, the CDP-RX-02E/CDP-RX-02EP should be mounted on the circuit board of the final product and must be enclosed in the case of the final product. No surface of the module should be exposed.

Conformity assessment of the final product

The manufacturer of the final system needs to conduct full EMC testing in the final configuration and also ensure the final product fulfills the health and safety requirements and is also responsible for the conformity assessment procedures of the final product in accordance with the RE Directive.

Important notice

- Customers are advised to consult with Circuit Design sales representatives before ordering. Circuit Design believes the provided information is accurate and reliable. However, Circuit Design reserves the right to make changes to this product without notice.
- Circuit Design products are neither designed nor intended for use in life support applications where malfunction can reasonably be expected to result in significant personal injury to the user. Any use of Circuit Design products in such safety-critical applications is understood to be fully at the risk of the customer and the customer must fully indemnify Circuit Design, Inc for any damages resulting from any improper use.
- As the radio module communicates using electronic radio waves, there are cases where transmission will be temporarily cut off due to the surrounding environment and method of usage. The manufacturer is exempt from all responsibility relating to resulting harm to personnel or equipment and other secondary damage.
- The manufacturer is exempt from all responsibility relating to secondary damage resulting from the operation, performance and reliability of equipment connected to the radio module.

Copyright

- All rights in this operation guide are owned by Circuit Design, Inc. No part of this document may be copied or distributed in part or in whole without the prior written consent of Circuit Design, Inc.

Cautions

- Do not use the equipment within the vicinity of devices that may malfunction as a result of electronic radio waves from the radio module.
- Communication performance will be affected by the surrounding environment, so communication tests should be carried out before actual use.
- Ensure that the power supply for the radio module is within the specified rating. Short circuits and reverse connections may result in overheating and damage and must be avoided at all costs.
- Ensure that the power supply has been switched off before attempting any wiring work.
- The case is connected to the GND terminal of the internal circuit, so do not make contact between the '+' side of the power supply terminal and the case.
- When batteries are used as the power source, avoid short circuits, recharging, dismantling, and pressure. Failure to observe this caution may result in the outbreak of fire, overheating and damage to the equipment. Remove the batteries when the equipment is not to be used for a long period of time. Failure to observe this caution may result in battery leaks and damage to the equipment.
- Do not use this equipment in vehicles with the windows closed, in locations where it is subject to direct sunlight, or in locations with extremely high humidity.
- The radio module is neither waterproof nor splash proof. Ensure that it is not splashed with soot or water. Do not use the equipment if water or other foreign matter has entered the case.
- Do not drop the radio module or otherwise subject it to strong shocks.
- Do not subject the equipment to condensation (including moving it from cold locations to locations with a significant increase in temperature.)
- Do not use the equipment in locations where it is likely to be affected by acid, alkalis, organic agents or corrosive gas.
- Do not bend or break the antenna. Metallic objects placed in the vicinity of the antenna will have a great effect on communication performance. As far as possible, ensure that the equipment is placed well away from metallic objects.
- The GND for the radio module will also affect communication performance. If possible, ensure that the case GND and the circuit GND are connected to a large GND pattern.

Warnings

- Do not take a part or modify the equipment.
- Do not remove the product label (the label attached to the upper surface of the module.) Using a module from which the label has been removed is prohibited.

Copyright 2019, Circuit Design, Inc.

Revision history

Version	Date	Description	Remark
1.0	Oct. 2019	The first issue	